



AFS60B-BEPK032768

AFS/AFM60 SSI

ABSOLUTE ENCODERS

SICK
Sensor Intelligence.



Illustration may differ



Ordering information

Type	Part no.
AFS60B-BEPK032768	1037984

Other models and accessories → www.sick.com/AFS_AFM60_SSI

Detailed technical data

Performance

Number of steps per revolution (max. resolution)	32,768 (15 bit)
Error limits G	0.05° ¹⁾
Repeatability standard deviation σ_r	0.002° ²⁾

¹⁾ In accordance with DIN ISO 1319-1, position of the upper and lower error limit depends on the installation situation, specified value refers to a symmetrical position, i.e. deviation in upper and lower direction is the same.

²⁾ In accordance with DIN ISO 55350-13; 68.3% of the measured values are inside the specified area.

Interfaces

Communication interface	SSI
Initialization time	50 ms ¹⁾
Position forming time	< 1 μ s
SSI	
Code type	Gray
Code sequence parameter adjustable	CW/CCW (V/R) parameter adjustable
Clock frequency	≤ 2 MHz ²⁾
Set (electronic adjustment)	H-active (L = 0 - 3 V, H = 4,0 - U _s V)
CW/CCW (counting sequence when turning)	L-active (L = 0 - 1,5 V, H = 2,0 - U _s V)
Sin/Cos	
Load resistance	$\geq 120 \Omega$

¹⁾ Valid positional data can be read once this time has elapsed.

²⁾ Minimum, LOW level (Clock +): 250 ns.

Electrical data

Connection type	Cable, 8-wire, universal, 1.5 m ¹⁾
Supply voltage	4.5 ... 32 V DC
Power consumption	≤ 0.7 W (without load)

¹⁾ The universal cable connection is positioned so that it is possible to lay it without bends in a radial or axial direction.

²⁾ This product is a standard product and does not constitute a safety component as defined in the Machinery Directive. Calculation based on nominal load of components, average ambient temperature 40°C, frequency of use 8760 h/a. All electronic failures are considered hazardous. For more information, see document no. 8015532.

Reverse polarity protection	✓
MTTFd: mean time to dangerous failure	250 years (EN ISO 13849-1) ²⁾

¹⁾ The universal cable connection is positioned so that it is possible to lay it without bends in a radial or axial direction.

²⁾ This product is a standard product and does not constitute a safety component as defined in the Machinery Directive. Calculation based on nominal load of components, average ambient temperature 40 °C, frequency of use 8760 h/a. All electronic failures are considered hazardous. For more information, see document no. 8015532.

Mechanical data

Mechanical design	Blind hollow shaft
Shaft diameter	12 mm
Weight	0.2 kg ¹⁾
Shaft material	Stainless steel
Flange material	Aluminum
Housing material	Aluminum die cast
Start up torque	< 0.8 Ncm ²⁾
Operating torque	< 0.6 Ncm ²⁾
Permissible movement static	± 0.5 mm (axial) ± 0.3 mm (radial)
Permissible movement dynamic	± 0.2 mm (axial) ± 0.1 mm (radial)
Moment of inertia of the rotor	40 gcm ²
Bearing lifetime	3.0 x 10 ⁹ revolutions
Angular acceleration	+ 500,000 rad/s ²
Operating speed	≤ 6,000 min ⁻¹ ³⁾

¹⁾ Relates to devices with male connector connection.

²⁾ At 20 °C.

³⁾ Allow for self-heating of approx. 3.3 K / 1,000 rpm when designing the operating temperature range.

Ambient data

EMC	According to EN 61000-6-2 and EN 61000-6-3 ¹⁾
Enclosure rating	IP65, shaft side (according to IEC 60529) IP67, housing side (according to IEC 60529) ²⁾
Permissible relative humidity	90 % (condensation of the optical scanning not permitted)
Operating temperature range	-40 °C ... +100 °C ³⁾
Storage temperature range	-40 °C ... +100 °C, without package
Resistance to shocks	70 g, 6 ms (according to EN 60068-2-27)
Resistance to vibration	30 g, 10 Hz ... 2,000 Hz (according to EN 60068-2-6)

¹⁾ EMC according to the standards quoted is achieved if shielded cables are used.

²⁾ For devices with connector connection: With mating connector mounted.

³⁾ Stationary position of the cable.

Classifications

ECl@ss 5.0	27270502
ECl@ss 5.1.4	27270502
ECl@ss 6.0	27270590
ECl@ss 6.2	27270590

ECl@ss 7.0	27270502
ECl@ss 8.0	27270502
ECl@ss 8.1	27270502
ECl@ss 9.0	27270502
ECl@ss 10.0	27270502
ECl@ss 11.0	27270502
ETIM 5.0	EC001486
ETIM 6.0	EC001486
ETIM 7.0	EC001486
UNSPSC 16.0901	41112113

Dimensional drawing (Dimensions in mm (inch))

Blind hollow shaft, cable outlet

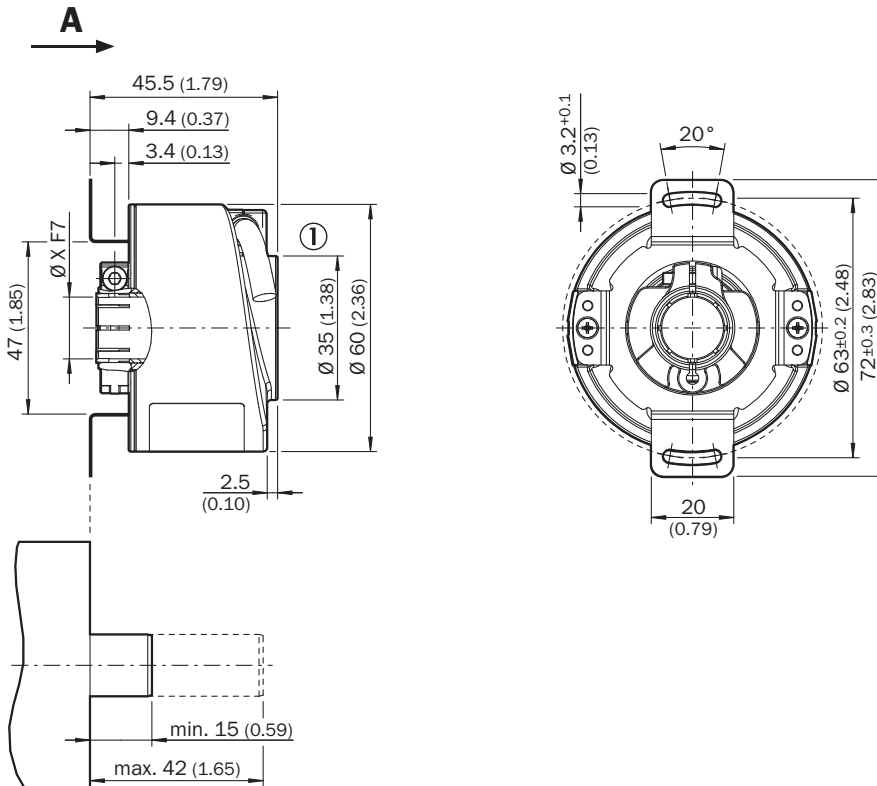

General tolerances according to DIN ISO 2768-mk

① Cable diameter = 5.6 mm +/- 0.2 mm bend radius = 30 mm

PIN assignment

M12 male connector, 8-pin and cable, 8-wire, SSI/Gray



View of M12 male device connector on encoder

PIN	Wire colors (cable connection)	Signal	Explanation
1	Brown	Data -	Interface signals
2	White	Data +	Interface signals
3	Black	V/R	Sequence in direction of rotation
4	Pink	SET	Electronic adjustment Interface signals
5	Yellow	Clock +	Interface signals
6	Purple	Clock -	Interface signals
7	Blue	GND	Ground connection
8	Red	U _S	Operating voltage
		Screen	Screen connected to housing on encoder side. Connected to ground on control side.

Maximum revolution range



The maximum speed is also dependent on the shaft type.

Diagrams

SSI data format singleturn



Bit 1–18: Position Bits

- LSB: Least significant Bit
- MSB: Most significant Bit

Bit 19–21: Error Bits

- ERRDIG: Failure message about speed. If this failure occurs during the position building procedure it will be indicated by the ERRDIG-Bit.
- ERRSI: Light source monitoring failure.
- ERRSYNC: Contamination of the disc or scanning system. During the determination of the position, an error has occurred since the last SSI transmission. The error bit will be deleted during the next data transmission.

The evaluation of the error bits has to be realized in the PLC.

The provided error bits don't have to be used by the PLC compulsorily.

Example

If the resolution of the absolute encoder is set on 13 bits, 16 bits are provided by the encoder: 13 data bits and 3 error bits. If the PLC is not able to evaluate the error bits, the PLC has to be set on a resolution of 13 bits. Then the error bits have to be masked out by the PLC.

SSI data format multiturn

30 Bits

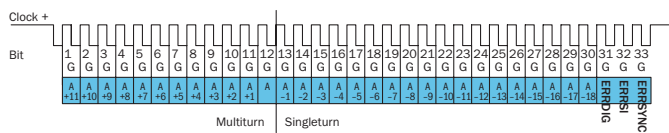

- Bit 1–12: Position Bits multiturn
- Bit 13–30: Position Bits singleturn
- Bit 31–33: Error Bits

27 Bits

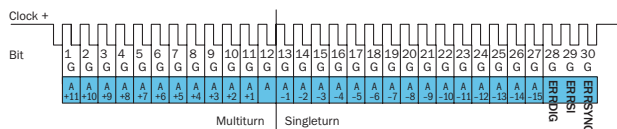

- Bit 1–12: Position Bits multiturn
- Bit 13–27: Position Bits singleturn
- Bit 28–30: Error Bits

Error Bits

- ERRDIG: Failure message about speed. If this failure occurs during the position building procedure it will be indicated by the ERRDIG-Bit.
- ERRSI: Light source monitoring failure.
- ERRSYNC: Contamination of the disc or scanning system. During the determination of the position, an error has occurred since the last SSI transmission. The error bit will be deleted during the next data transmission.

The evaluation of the error bits has to be realized in the PLC.

The provided error bits don't have to be used by the PLC compulsorily. The multiturn resolution is fixed on 12 bits.

Example

If the resolution of the absolute encoder is set on 27 bits, 30 bits are provided by the encoder: 27 data bits and 3 error bits. If the PLC is not able to evaluate the error bits, the PLC has to be set on a resolution of 27 bits. Then the error bits have to be masked out by the PLC.

Electrical interfaces sine 0.5 V_{pp}

Power supply	Output
4.5 ... 5.5 V	Sine 0.5 V _{pp}

Signal before differential generation at load 120 Ω at U_s = 5 V

Signal diagram for clockwise rotation of the shaft looking in direction "A" (shaft)

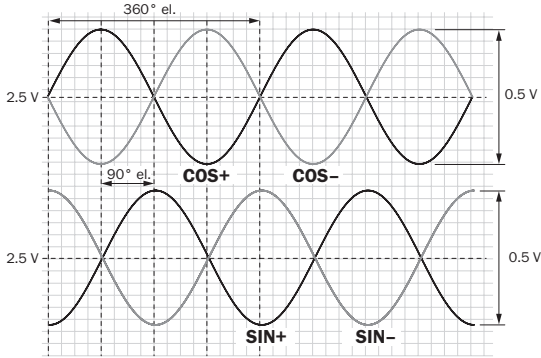

Interface signals Sin, $\overline{\text{Sin}}$, Cos, $\overline{\text{Cos}}$	Signal before differential generation at load 120 Ω	Signal offset
Analog differential	0.5 V _{pp} ± 20 %	2.5 V ± 10 %

Signal after differential generation at load 120 Ω at U_s = 5 V

Signal diagram for clockwise rotation of the shaft looking in direction "A" (shaft)

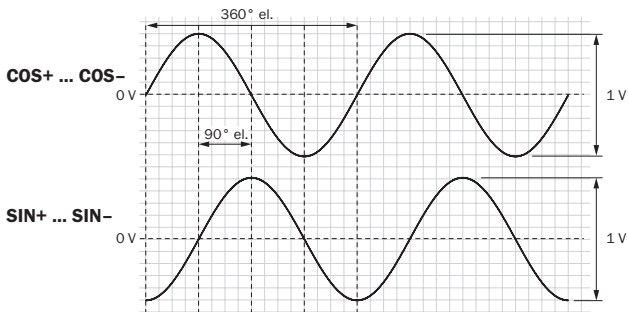





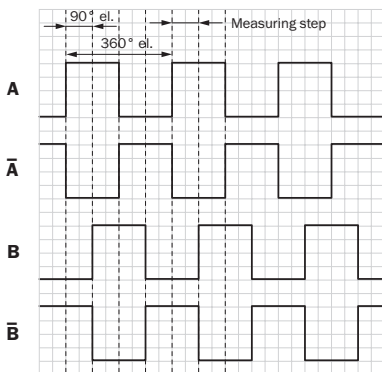

Electrical interfaces HTL/TTL

Incremental pulse diagram for clockwise rotation of the shaft looking in direction "A", see dimensional drawing



Recommended accessories

Other models and accessories → www.sick.com/AFS_AFM60_SSI

	Brief description	Type	Part no.
Plug connectors and cables			
	Head A: female connector, terminal box, 8-pin, straight Head B: male connector, D-Sub, 9-pin, straight Cable: SSI + incremental, PVC, shielded, 0.5 m Programming adapter cable for programming tool PGT-10-Pro and PGT-08-S	DSL-0D08-G0M5AC3	2061739
	Head A: male connector, M12, 8-pin, straight, A-coded Head B: - Cable: Incremental, shielded	STE-1208-GA01	6044892
	Head A: male connector, M23, 12-pin, straight Head B: - Cable: HIPERFACE®, SSI, Incremental, RS-422, shielded	STE-2312-G	6027537
	Head A: male connector, M23, 12-pin, straight Head B: - Cable: HIPERFACE®, SSI, Incremental, shielded	STE-2312-G01	2077273
		STE-2312-GX	6028548
Programming and configuration tools			
	USB programming unit, for programmable SICK encoders AFS60, AFM60, DFS60, VFS60, DFV60 and wire draw encoders with programmable encoders	PGT-08-S	1036616
	Programming unit display for programmable SICK DFS60, DFV60, AFS/AFM60, AHS/AHM36 encoders, and wire draw encoder with DFS60, AFS/AFM60 and AHS/AHM36. Compact dimensions, low weight, and intuitive operation.	PGT-10-Pro	1072254

SICK AT A GLANCE

SICK is one of the leading manufacturers of intelligent sensors and sensor solutions for industrial applications. A unique range of products and services creates the perfect basis for controlling processes securely and efficiently, protecting individuals from accidents and preventing damage to the environment.

We have extensive experience in a wide range of industries and understand their processes and requirements. With intelligent sensors, we can deliver exactly what our customers need. In application centers in Europe, Asia and North America, system solutions are tested and optimized in accordance with customer specifications. All this makes us a reliable supplier and development partner.

Comprehensive services complete our offering: SICK LifeTime Services provide support throughout the machine life cycle and ensure safety and productivity.

For us, that is “Sensor Intelligence.”

WORLDWIDE PRESENCE:

Contacts and other locations –www.sick.com